

PRODUCT DATA SHEET

Burlington[®]



PRODUCT CODE

GU5600DAG_FS

RANGE

Guild

DESCRIPTION

Guild Floor Standing Vanity 560mm
Ashbee Grey c/w handles

CATEGORY	Furniture
WARRANTY DETAILS	10 Years
COLOUR	Ashbee Grey
FINISH APPLICATION	Lacquered
PRIMARY MATERIAL	MDF
INSTALL TYPE	Floor Standing
PRODUCT WIDTH MM	498
PRODUCT HEIGHT MM	765
PRODUCT DEPTH MM	478
PRODUCT NET WEIGHT KG	22.5
STANDARDS	EN14749:2016

COLOUR CODE / REFERENCE	NCS S8000-N
DRAWER BOX	MDF
DRAWER RUNNERS	DTC / SS10C350H1
DRAWER EXTENSION	Full extension
DRAWER ADJUSTMENT	2 way adjustment
WALL HANGERS	No
ADJUSTABLE FEET	Yes
DRAWER CAPACITY	15 kgs
DRAWER OPERATION	Soft close

TECHNICAL DIMENSIONS

Dimensions in mm unless otherwise specified.

Tolerances (per material type) apply.

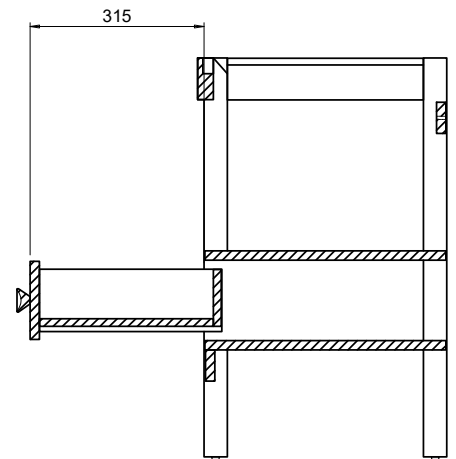
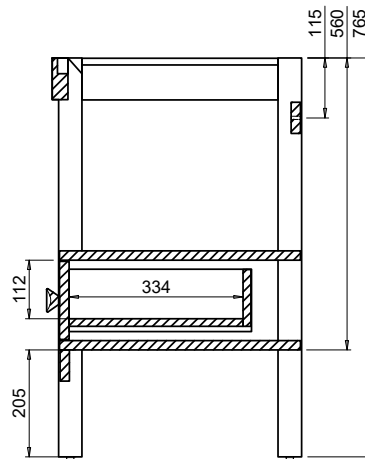
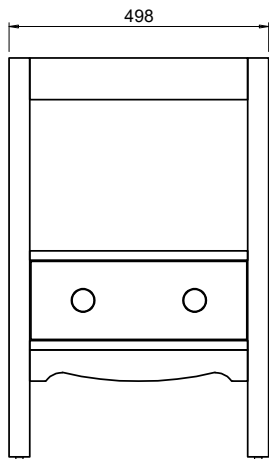
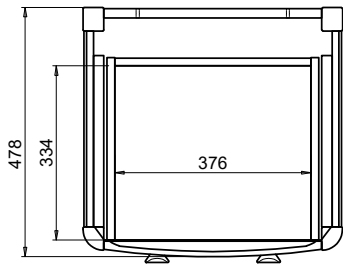

SPARES LIST

Only the parts labelled are available as spares.

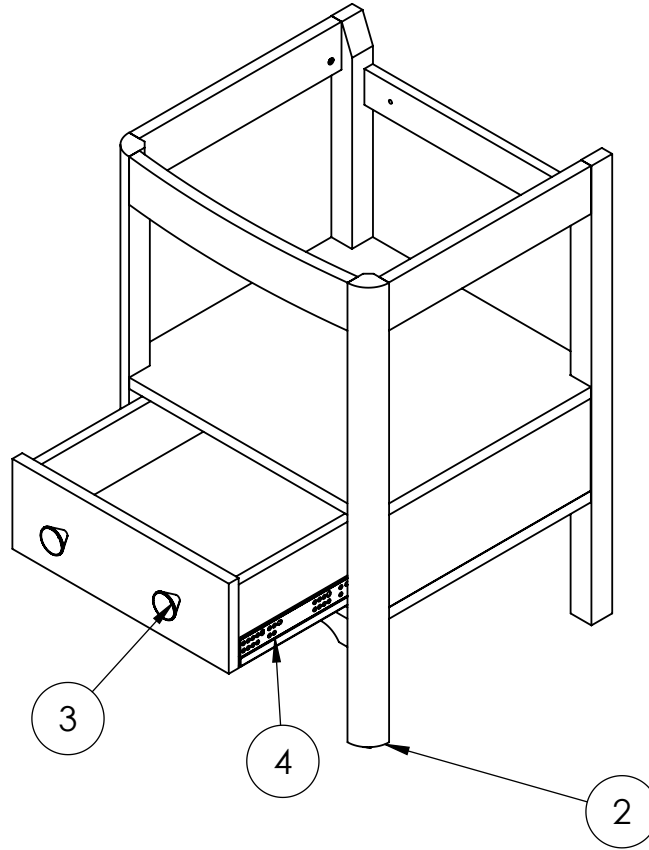

NUMBER	PART CODE	DESCRIPTION
1	SP1785	Guild Fixing pack for floor standing vanity GU5600D,GU6500D,GU8500D
2	SP1788	Guild Bottom feet for floor standing vanity GU5600D,GU6500D,GU8500D
3	SP1789	Guild Handle pair for floor standing vanity GU5600D,GU6500D,GU8500D Varley White DN45mm
	SP1790	Guild Handle pair for floor standing vanity GU5600D,GU6500D,GU8500D Carlyle Green DN45mm
	SP1791	Guild Handle pair for floor standing vanity GU5600D,GU6500D,GU8500D Ashbee Grey DN45mm
4	RUNNERSGUILD	Guild runners x 1 KIT Left & Right