

## After Care Service

### Cleaning your product

When cleaning the mirror or any mirrored surfaces it is recommended to use a soft, dry, non abrasive cloth with the mirror turned off. Do not use cleaning agents or abrasive materials.

Do not allow moisture to come into contact with any electrical components.

### Troubleshooting & After care service

For any further assistance, please contact our tech support team at: 01225 787 870.

We reserve the right to amend the specification of its products at any time if an opportunity to improve the product occurs. All dimensions are approximate and are quoted within reasonable tolerances.

### Compliance

This product complies with all relevant British and European safety standards. This product contains light source(s) of energy class F (EU) 2019/2020 and (EU) 2019/2015



Customer Services, Brassmill Lane Trading Estate, Bath BA1 3JF.  
Tel 01225 303900 | [www.tavistockbathrooms.co.uk](http://www.tavistockbathrooms.co.uk)

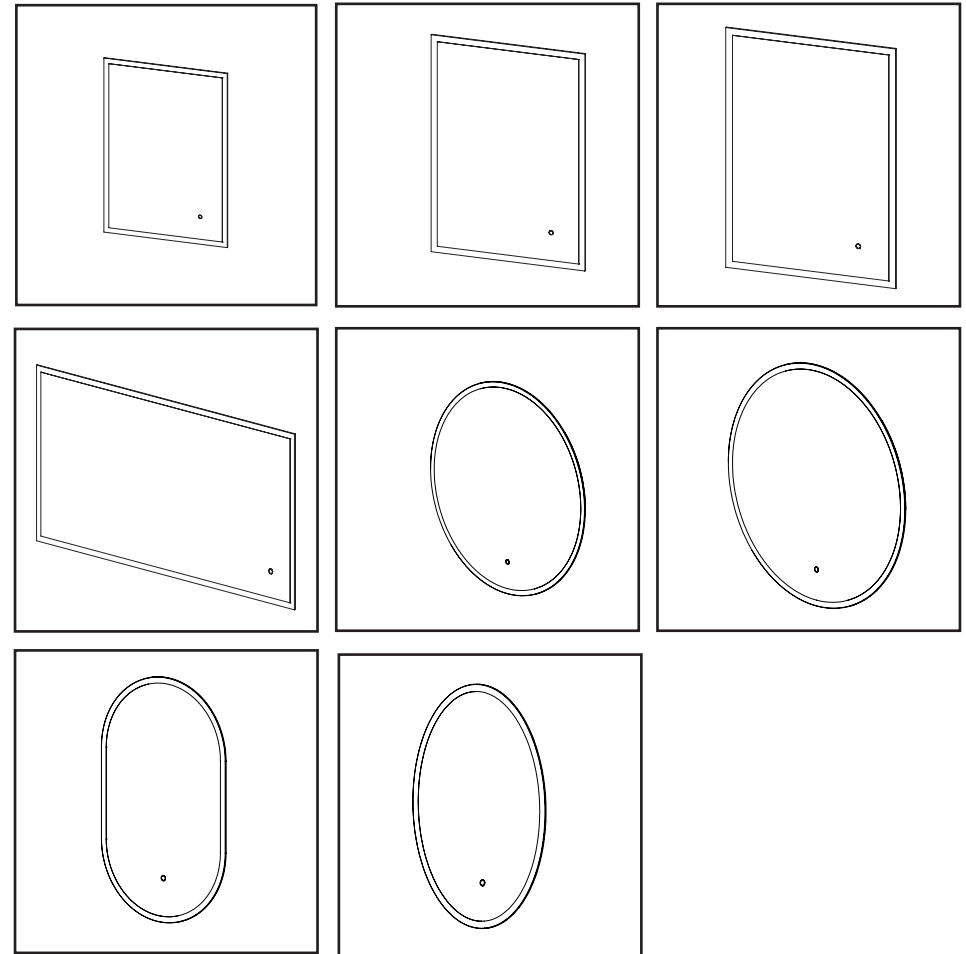

## BETA

### LED Illuminated Mirror Installation & Aftercare Instructions

Retain for future reference

## Electrical Safety

Suitable for UK Installations only.

All fittings must be installed by a competent person, in accordance with current IEE wiring regulations. If in doubt consult a qualified electrician.

**Important:** Always switch off the electrical supply at the mains before installation and maintenance. It is recommended that the fuse is withdrawn or the circuit breaker is switched off for the necessary circuit before installation commences.

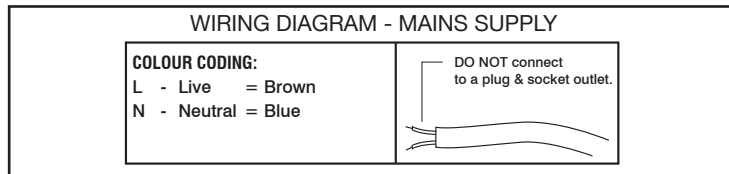

## Bathroom Zones

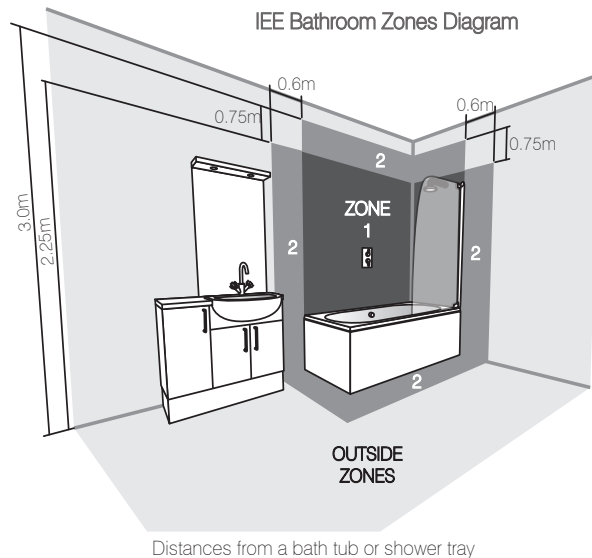

Bathroom fittings are subject to the appropriate zones in accordance with IEE Regulations. This product is only suitable for permanent indoor installation in Zone 2 and outside zones. (See above) This product is not suitable for installation in Zone 0 or 1, saunas, steam rooms or shower cubicles. Do not connect to a trailing plug and socket. Do not install onto surfaces that are either damp or electrically conductive.

## Installation Procedure

**Important:** Before starting the installation process, make sure the electrical supply is switched off. It is recommended that the fuse is withdrawn or the circuit breaker is switched off for the necessary circuit.

**Important:** Before starting the installation process, ensure the wall construction is suitable and can support the weight of the mirror.

**Note:** The wall plugs supplied are suitable for solid stone / brick walls. For any other wall material use specialist wall plugs.

- 1) Measure the distance (X) between the keyhole slots on the back of the mirror.
- 2) Mark out the fixing screw positions on the wall using a pencil to the desired height, ensuring they are spaced at distance (X).

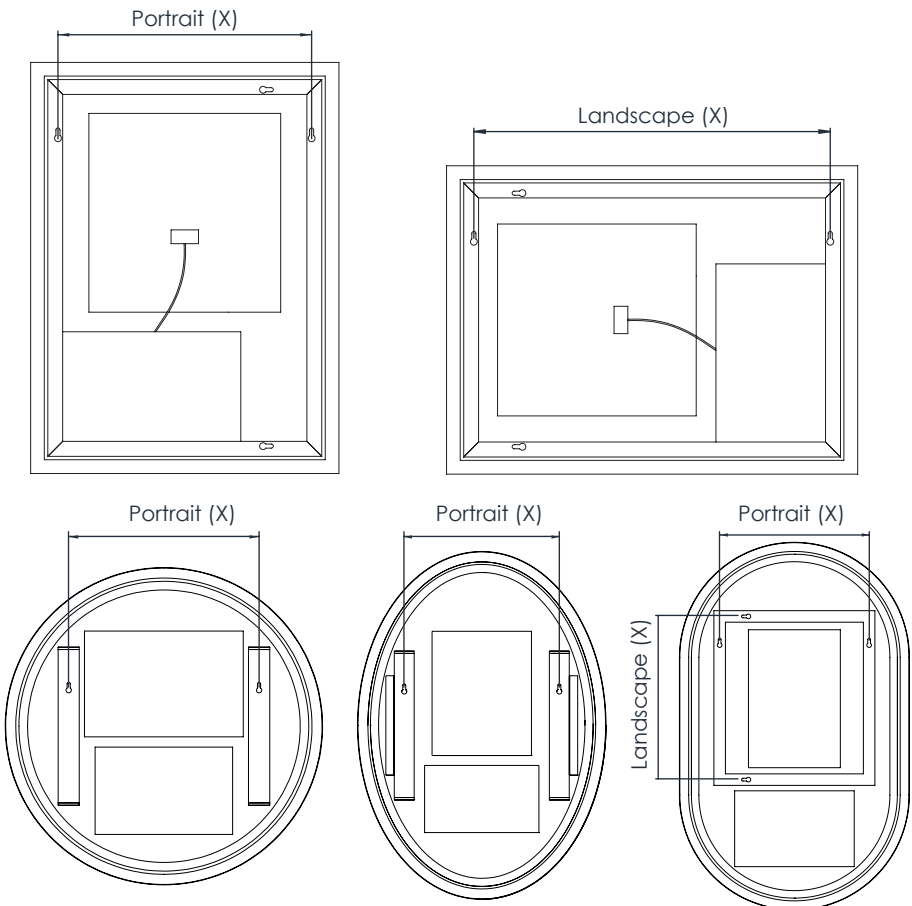

## Installation Procedure

3) Drill the marked out positions and fit the wall plugs accordingly. Fix the screw into position, leaving a small amount of the screw head proud of the wall for hanging.

4) Make the electrical connection from the mirror to the mains supply. Use the connection wire found at the rear of the mirror to make the necessary connections in accordance with the current IEE regulations. A second person will need to hold the mirror in place whilst electrical connections are made.

5) The mirror should easily slide onto the fixing screws and secure into place.

**NOTE:** To secure the mirror further, a small amount of silicone sealant can be applied to the side of the extrusions to prevent the mirror being accidentally pulled away from the wall.

To remove the mirror, the mirror should first be lifted and then pulled away from the wall.

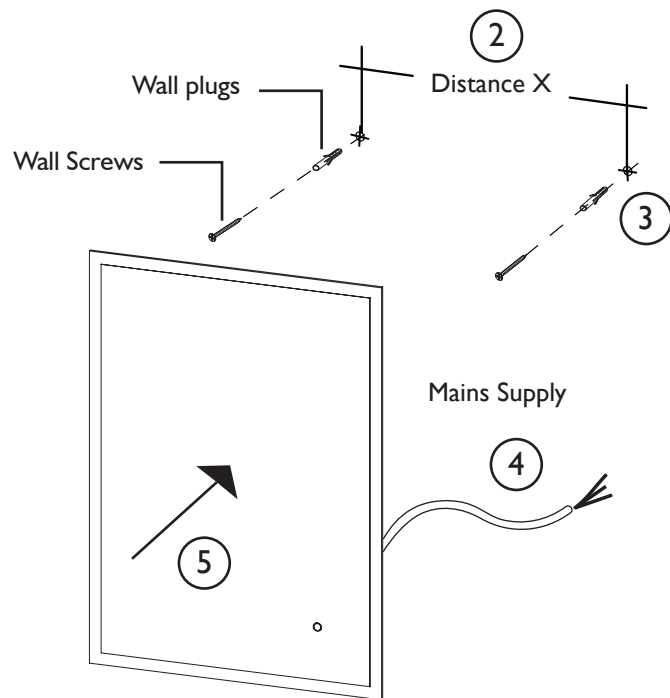

## Operating Instructions

The mirror comes with LED lighting and heated demister Pad, which is controlled via a fixed **Touch sensor**. The lighting can be controlled using the button functions detailed below:

### Turn Mirror ON/OFF

To turn the product on/off, short press the touch sensor. When the product is on, the heated demister will turn on.

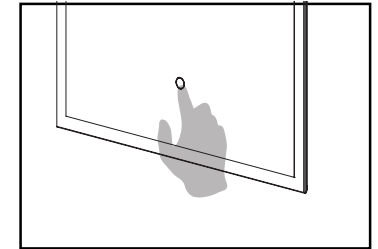

### Change LED colour

1. When the product is ON
2. Quickly double press the touch sensor to cycle through the colour temperature options. (3000k, 4000K and 6500K)

**Note:** The colour temperature will be memorised.

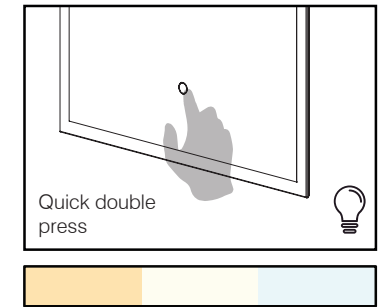

Warm White 3000K → Natural White 4000K → Daylight White 6500K

### Change LED intensity

1. When the product is ON
2. Press and hold the touch sensor to adjust its brightness.
3. Remove hand from touch sensor once desired intensity is reached.

**Note:** The brightness will be memorised.

