

### Tools Required (not supplied)

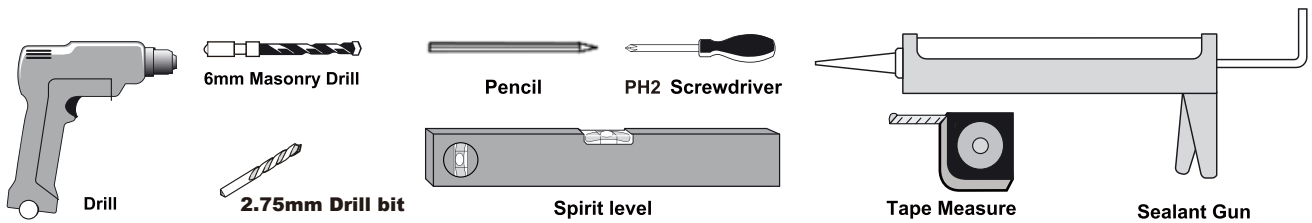

**Note:** Instruction shows fitting of a Side panel with a Pivot door as an example only. This Side panel can fit with the Sliding door, Bifold door and Hinge door etc.

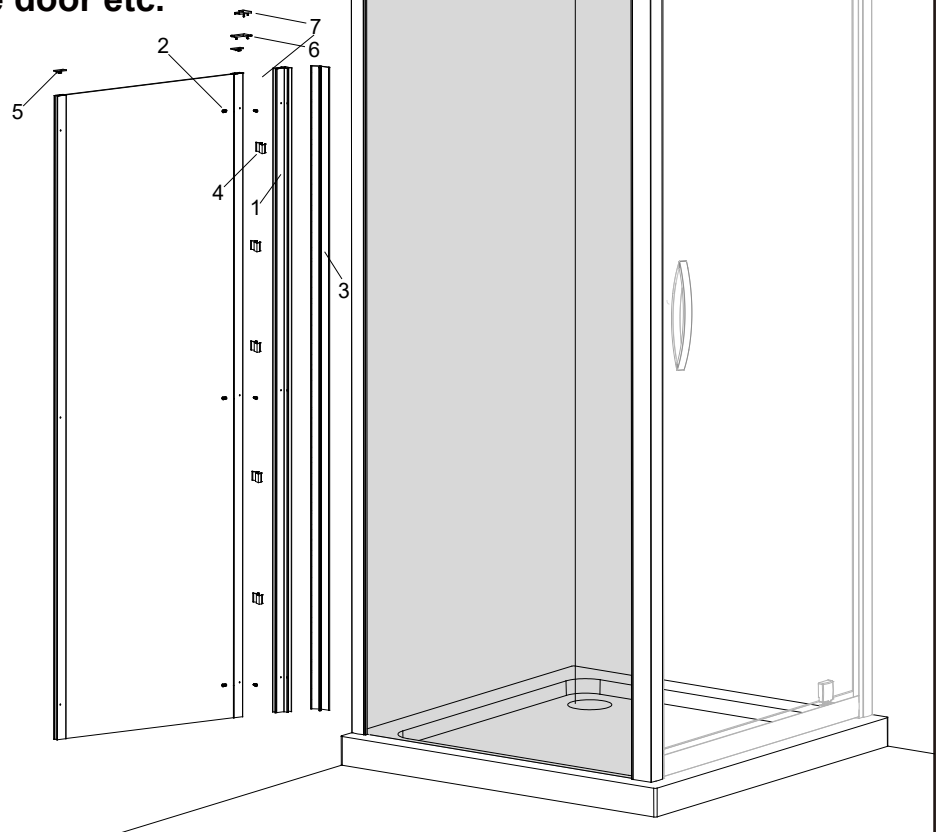

Item	Description	Image	Qty
1	Corner Post		1
2	Screw ST4x12		3
3	Cover Strip		1
4	Cover Clip		5
5	Upright Profile Cap		2
6	Corner Profile Cap - LH		1
7	Corner Profile Cap - RH		1

### Important Safety/Assembly Instructions

This product should be installed by a suitably qualified and proficient person. The fitting instructions should be followed carefully to ensure a proper and safe installation. Failure to follow these instructions could result in future injury.

These instructions and list of parts assume that installation is done against solid/tiled walls.

Please check this product for damage prior to starting the installation. No claims can be made after the product has been fitted.

PLEASE NOTE :The minimum and maximum adjustment sizes noted on the product brochures are based on perfectly plumb walls and trays.

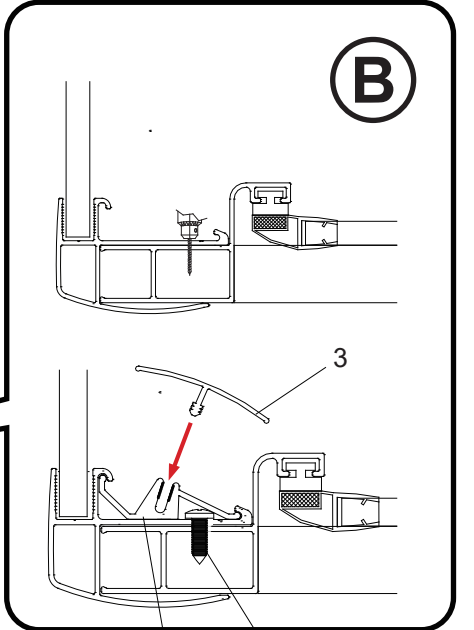
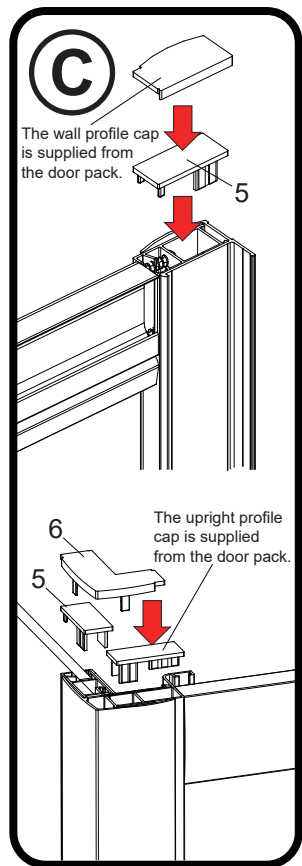
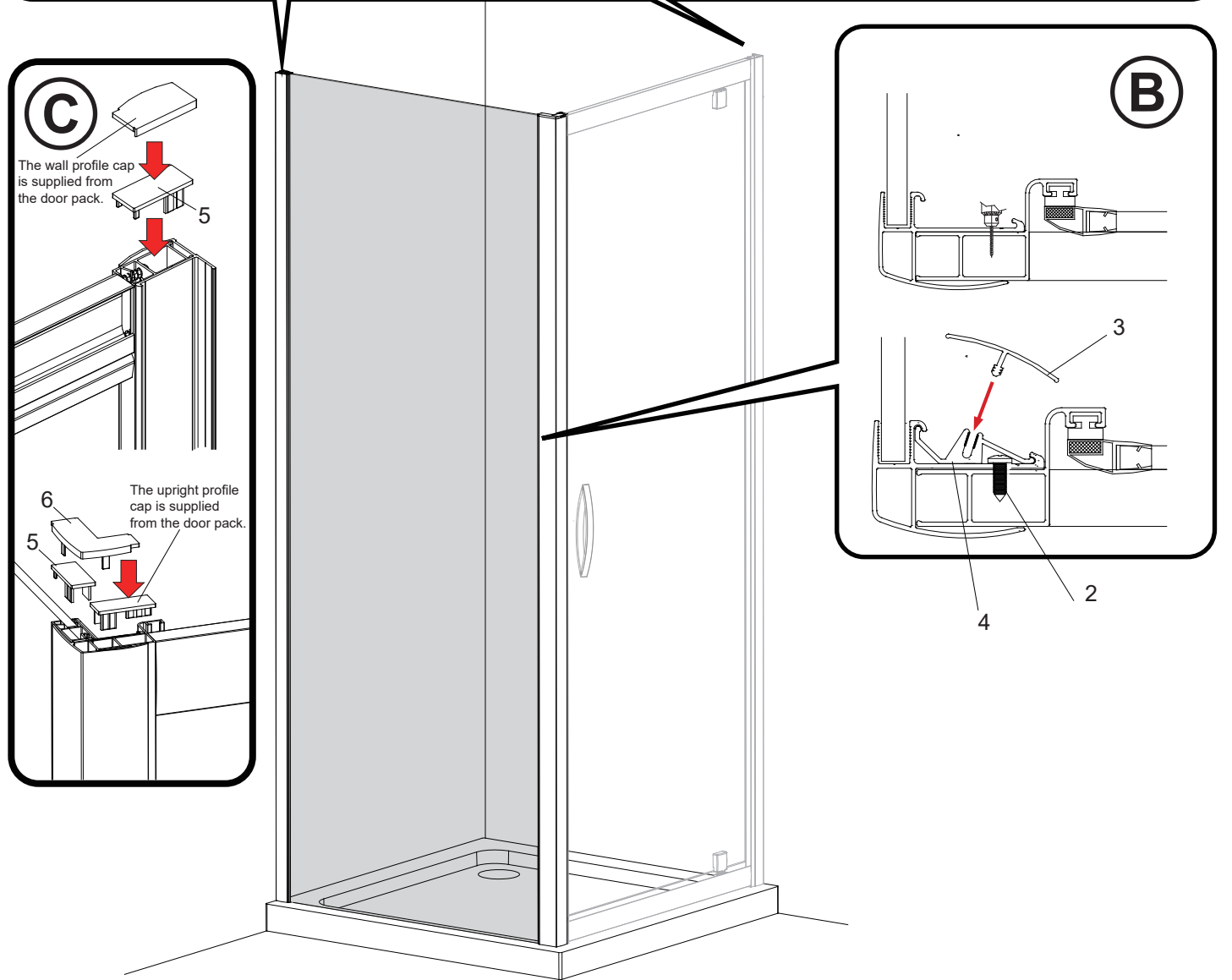
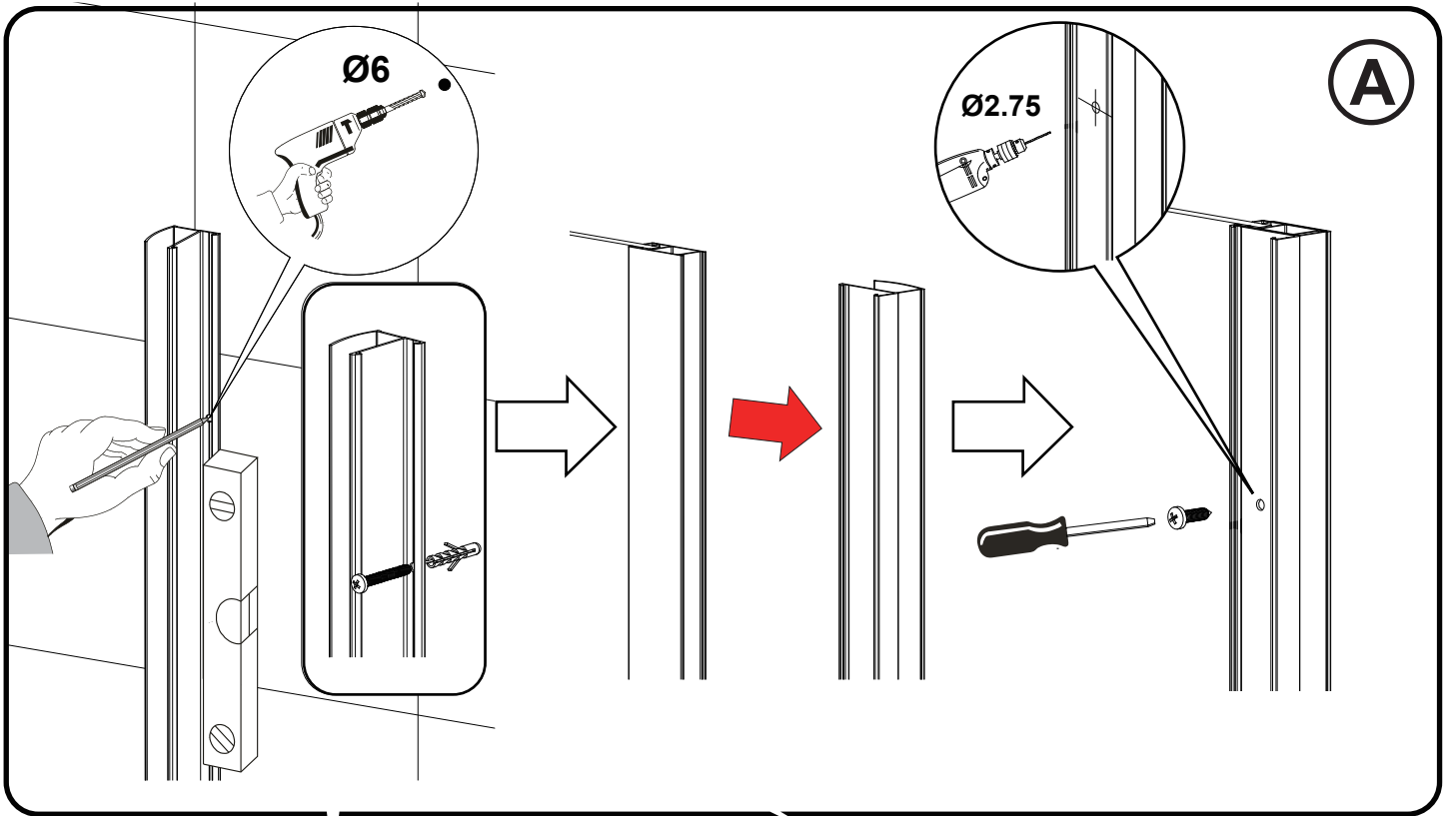

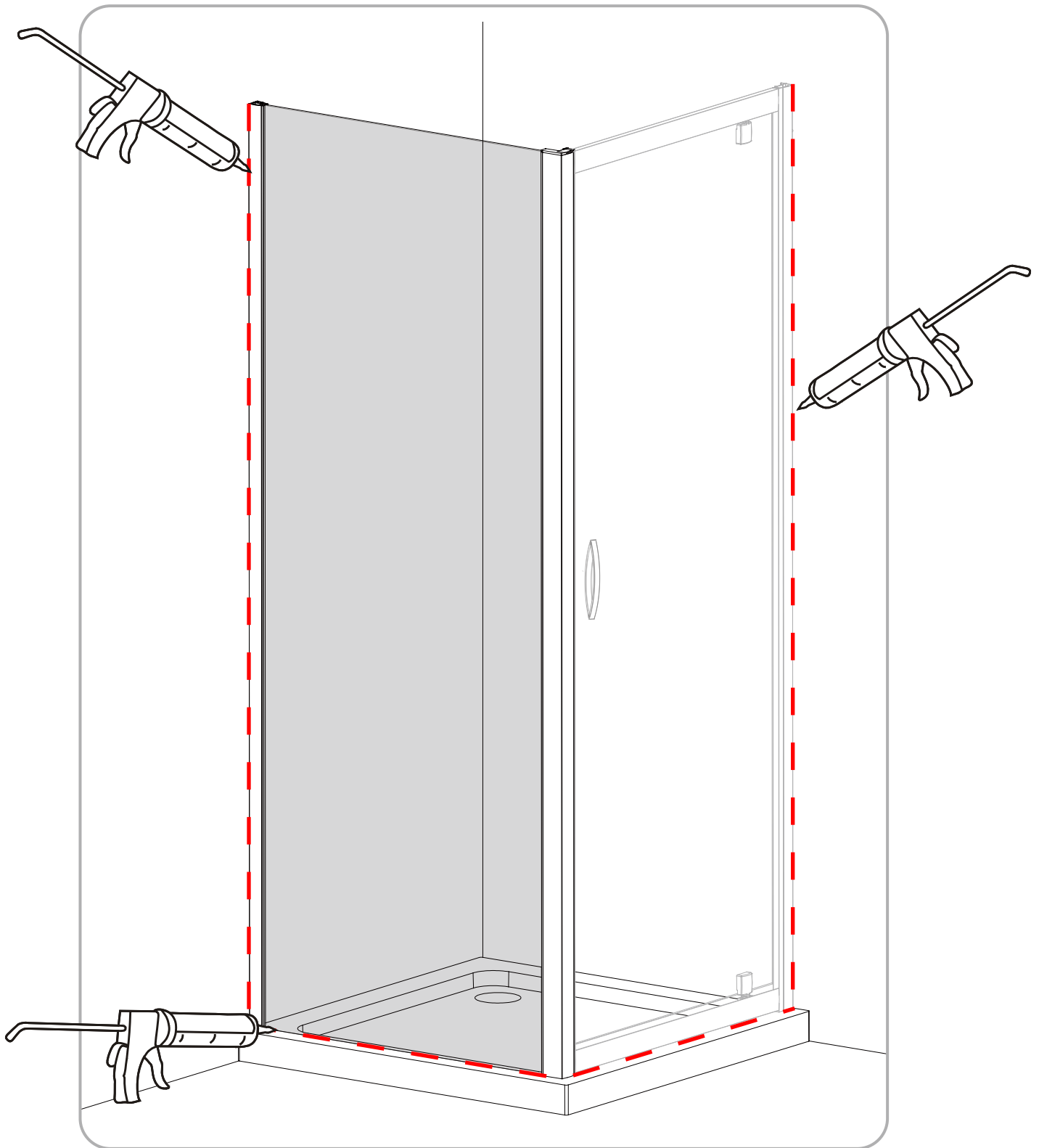

### Applying Silicone Sealant

#### Sealing Inside

Seal from the top of the wall profile to the bottom on the **INSIDE** between the wall profile and the wall.

**IMPORTANT:** Do not apply sealant on inside of tray.

#### Sealing Outside

Seal only along the bottom rail and glass on the **OUTSIDE** between the profile /glass and the tray. Also up between the wall profile and the wall.

Seal also the joints between the bottom profile and any upright profiles.

**24 HRS**



**DO NOT USE THE  
ENCLOSURE FOR  
24 HOURS AFTER  
SEALING**

## AFTERCARE

### Cleaning Instructions

It is important to clean your Artesan<sup>®</sup> shower enclosure after every use. Please wipe down all glass and metal parts with a clean soft cloth. Ensure that all residual water on the glass is removed after every use.

### Usage

For reliable, watertight performance from your Artesan<sup>®</sup> enclosure your shower head should not be positioned so that the shower sprays directly onto the enclosure door. Failure to comply with this may cause the shower to leak. Outward opening doors may cause water to drip onto the floor, please ensure that the floor covering immediately outside the enclosure will not be affected by water.



---

This product has been treated with PureGLAZE<sup>™</sup> easy clean glass treatment, a protective barrier which creates a 'non-stick' surface on your glass, helping to resist lime scale build up and water spots.

### Aftercare

PureGLAZE<sup>™</sup> glass can be cleaned with any suitable nonabrasive glass cleaner - with PH value of between 3-11; the coating will not be damaged. Avoid surfactants and heavily perfumed products. Vinegar and water based products are very effective. Do not use abrasive scrubbing cleaners or equipment for cleaning.