

Artesan[®]

Hapi6

ASSEMBLY GUIDE

SINGLE & SAIL BATH SCREEN

Tools Required (not supplied)



Drill



8mm Masonry Drill



2.75mm HSS Drill Bit



Pencil



PH2 Screwdriver

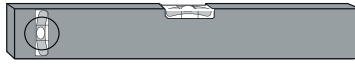

Spirit level

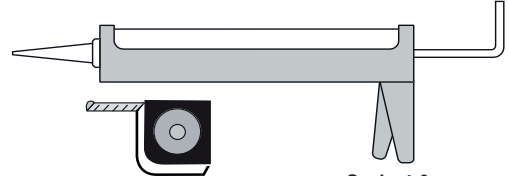

Tape Measure

Sealant & Sealant Gun

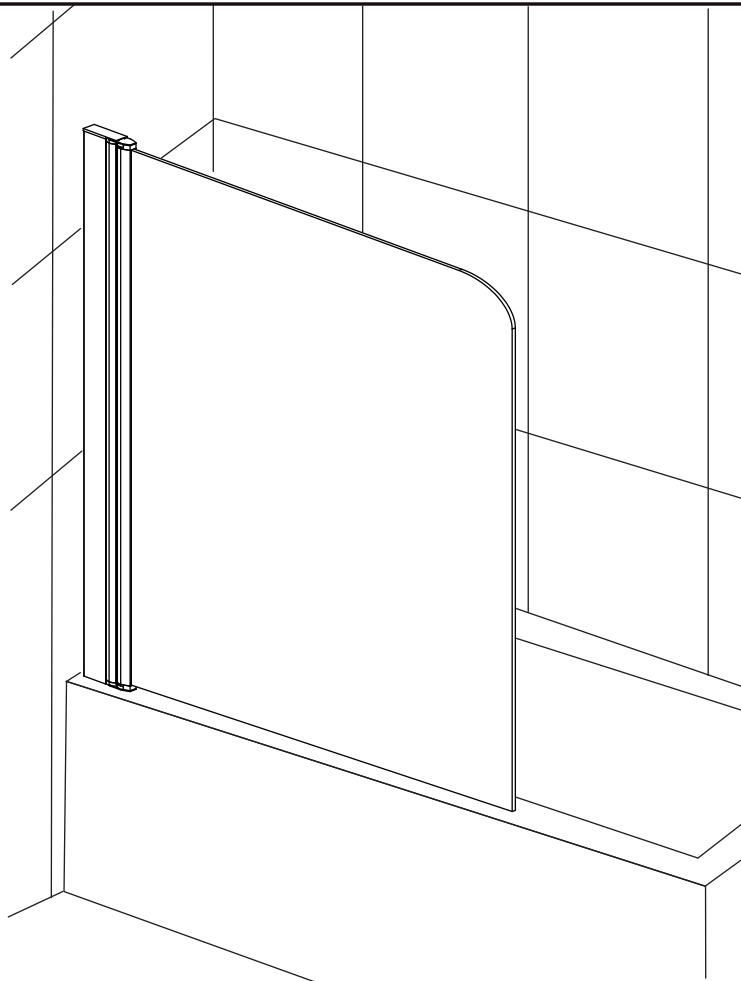

ASSEMBLY INSTRUCTIONS IMPORTANT PLEASE READ

The screen can be constructed either way up, for left or right hand opening.

These instructions and list of parts assume that installation is done against solid/tiled walls. Hollow or stud partition walls will require alternative fixings. Please consult with a reputable, qualified trades person.

Please check this product for damage prior to starting the installation. No claims can be made after the product has been fitted.







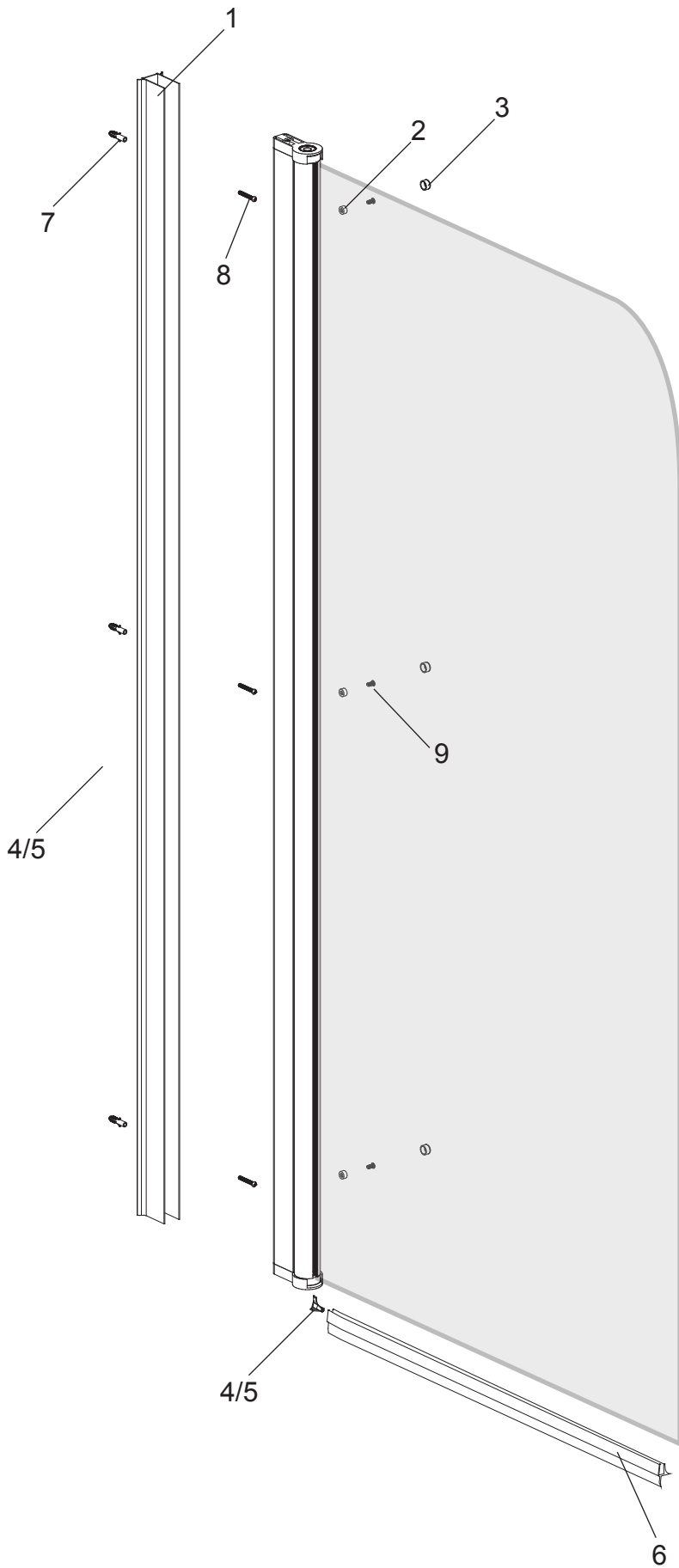

Please note the minimum and maximum adjustment sizes noted on the product brochures are based on perfectly plumb walls and trays.

IMPORTANT: If you are at all unsure of any part of the instructions shown in this document we recommend that you contact a reputable qualified trades person.

PLEASE ENSURE THAT YOUR BATH IS LEVEL AND INSTALLED CORRECTLY AND FULLY TO THE TILES PRIOR TO FITTING OF THE ENCLOSURE.

USE SAFETY EYE-WEAR WHEN DRILLING



Item	Description	Image	Qty
1	Wall Profile		1
2	Universal Screw Cup		3
3	Universal Screw Cap		3
4	Bath Screen Seal Stopper - LH		1
5	Bath Screen Seal Stopper - RH		1
6	Bottom Seal		1
7	Wall Plug		3
8	Screw ST3.5×30		3
9	Screw ST4×12		3

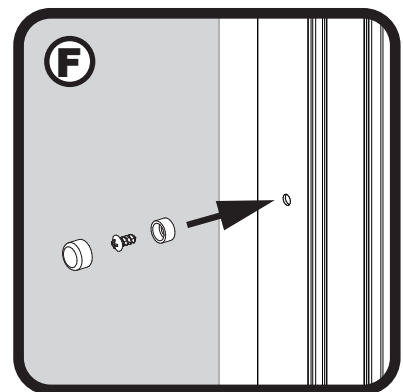
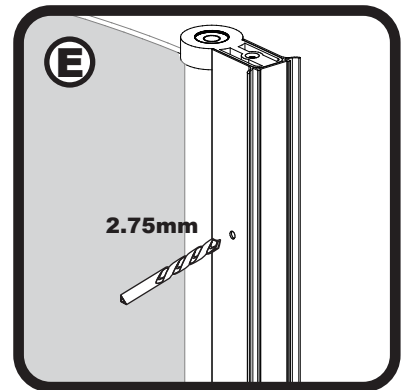
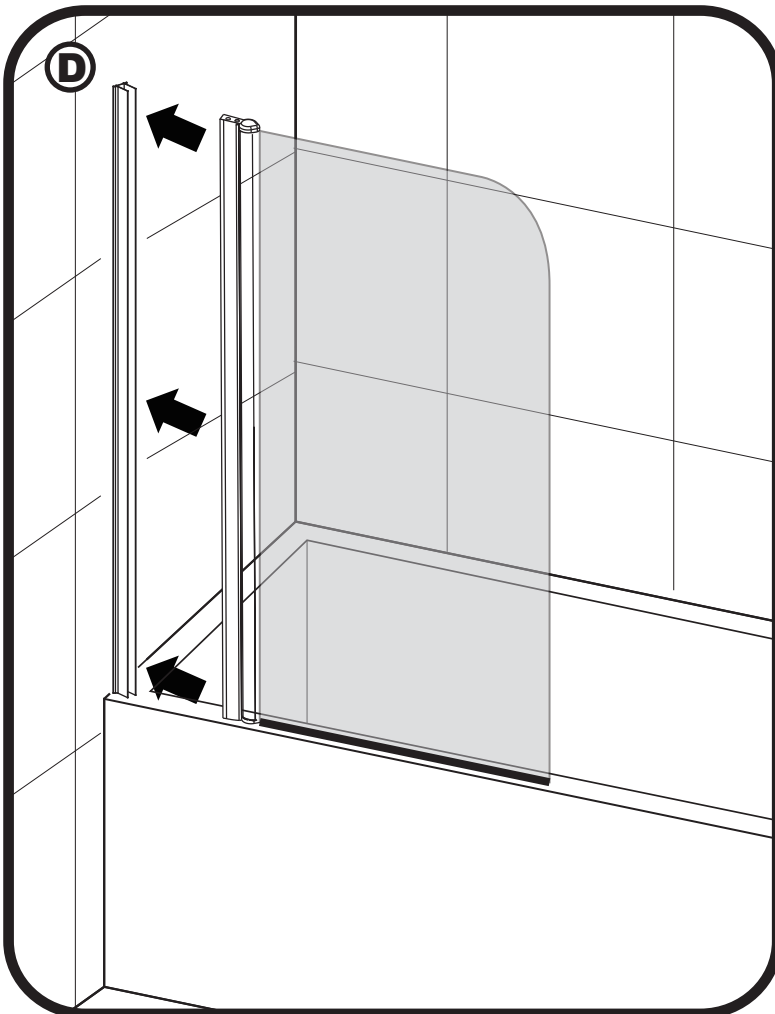
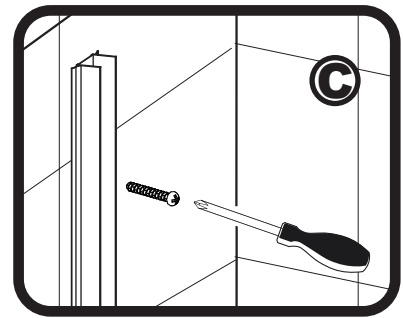
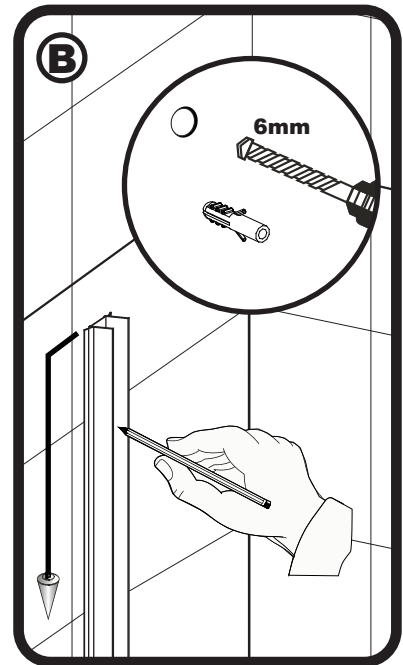
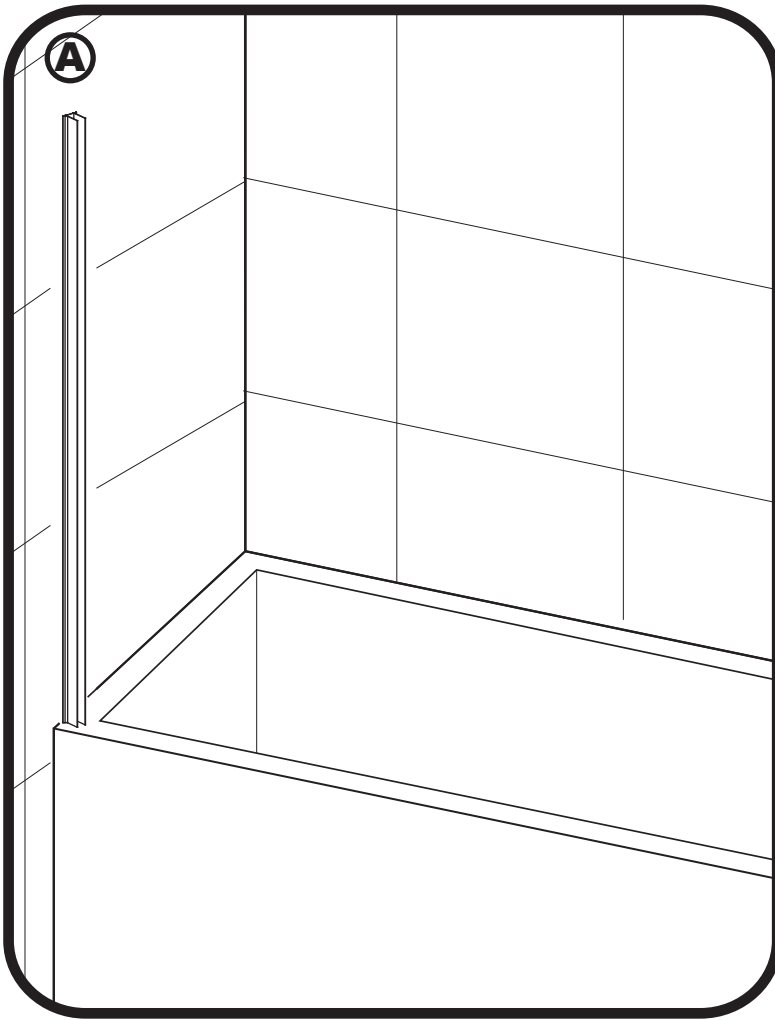

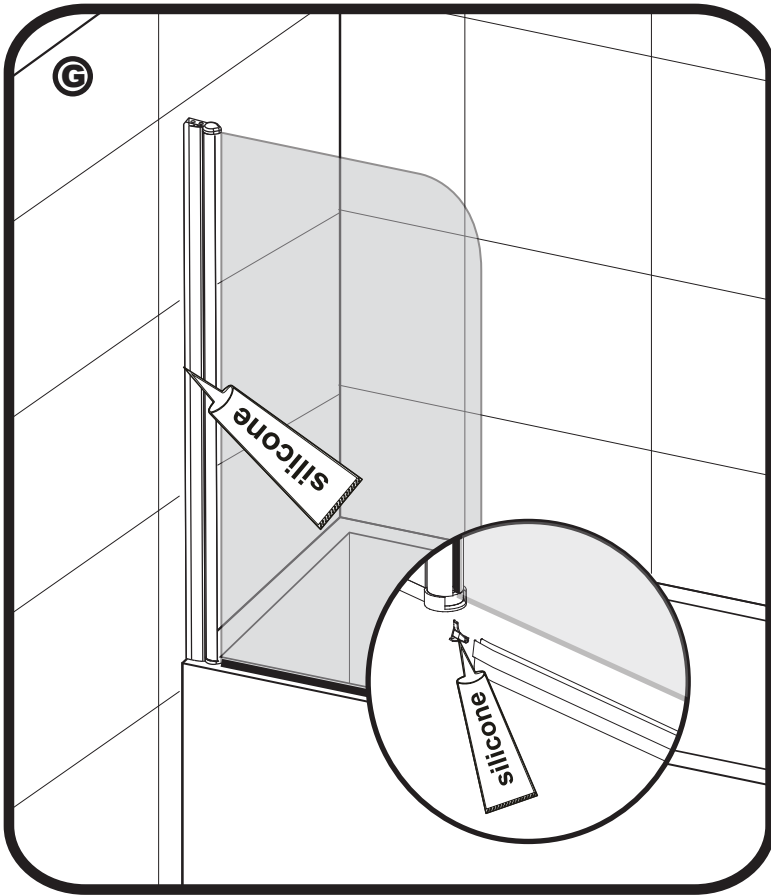

24 HRS	<p>DO NOT USE THE ENCLOSURE FOR 24 HOURS AFTER SEALING</p>

Tips - In cold weather the seal may be more difficult to fit. In this case it is advisable to warm the seal in some warm soapy water to make it more pliable.

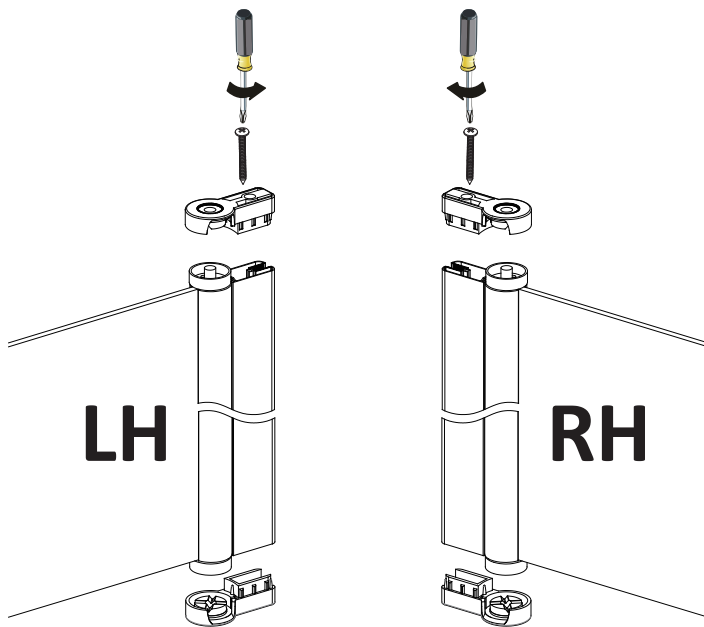

Note:

The cut of the hinge must be placed inside of the bath.

You need to swap the top and bottom hinges if you need to assemble the Radius bath screen (Or Sail bath screen) to the right hand side.

The Radius bath screen (Or Sail bath screen) is pre-assembled for left hand side.

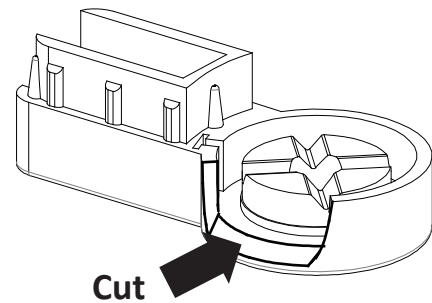

AFTERCARE

Cleaning Instructions

It is important to clean your Artesan® shower enclosure after every use. Please wipe down all glass and metal parts with a clean soft cloth. Ensure that all residual water on the glass is removed after every use.

Usage

For reliable, watertight performance from your Artesan® enclosure your shower head should not be positioned so that the shower sprays directly onto the enclosure door. Failure to comply with this may cause the shower to leak. Outward opening doors may cause water to drip onto the floor, please ensure that the floor covering immediately outside the enclosure will not be affected by water.

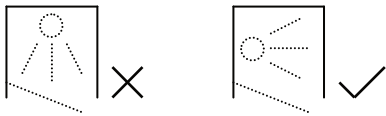

This product has been treated with PureGLAZE™ easy clean glass treatment, a protective barrier which creates a 'non-stick' surface on your glass, helping to resist lime scale build up and water spots.

Aftercare

PureGLAZE™ glass can be cleaned with any suitable nonabrasive glass cleaner - with PH value of between 3-11; the coating will not be damaged. Avoid surfactants and heavily perfumed products. Vinegar and water based products are very effective. Do not use abrasive scrubbing cleaners or equipment for cleaning.